



2021+ FORD F SERIES AMPS DASH MOUNT USER GUIDE

Description	Part Number
2021+ FORD F-150 AMPS DASH MOUNT	AS4.C235.014
2021+ FORD F-250 F-550 XLT AMPS DASH MOUNT	AS4.C235.015
2021+ FORD F-250 F-550 XL AMPS DASH MOUNT	AS4.C235.017

Product Mounting Disclaimer

Precision Mounting Technologies Ltd (PMT) are not liable under any theory of contract or tort law for any loss, damage, personal injury, special, incidental or consequential damages for personal injury or other damage of any nature arising directly or indirectly as a result of the improper installation or use of its products in vehicle or any other application. In order to safely install and use PMT products full consideration of vehicle occupants, vehicle systems (i.e., the location of fuel lines, brake lines, electrical, drive train or other systems), air-bags and other safety equipment is required. PMT specifically disclaims any responsibility for the improper use or installation of its products not consistent with original vehicle manufactures' specifications and recommendations, PMT product instruction sheets, or workmanship standards as endorsed through PMT policies and EULA.



PRODUCT VISUALS

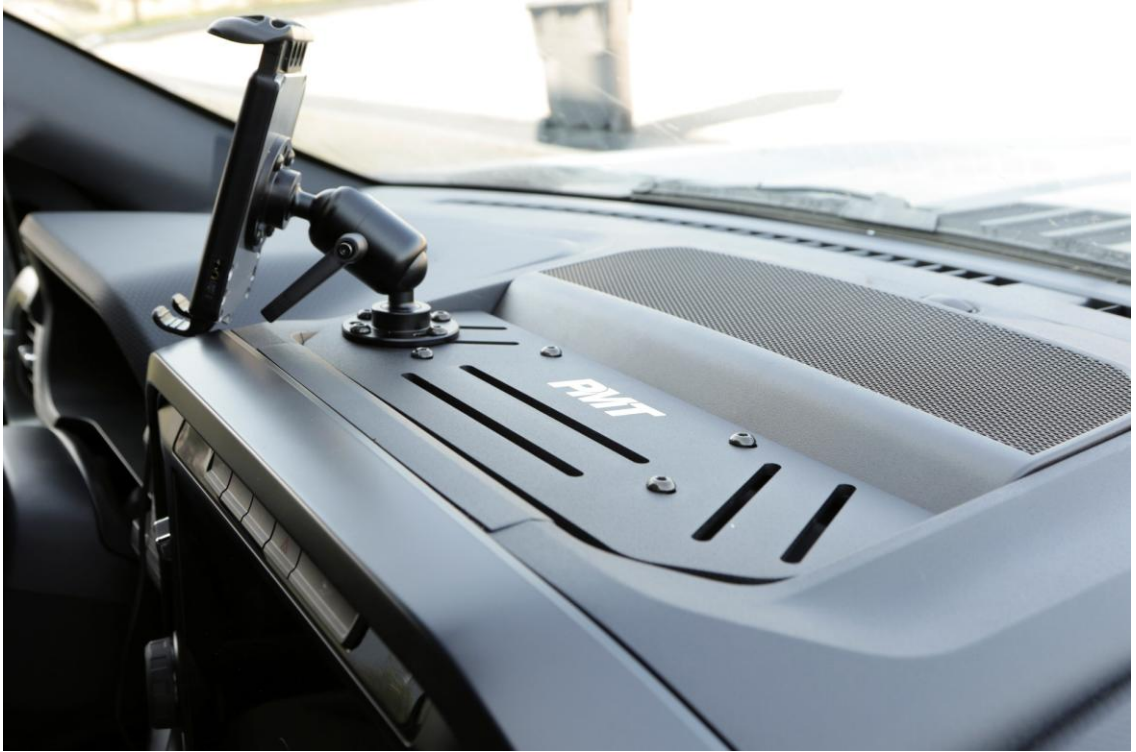

A 2024 Ford F-150 was used for this installation. Exact install process may vary by vehicle model, trim and year.

DESCRIPTION OF PARTS

(AS4.C235.014)

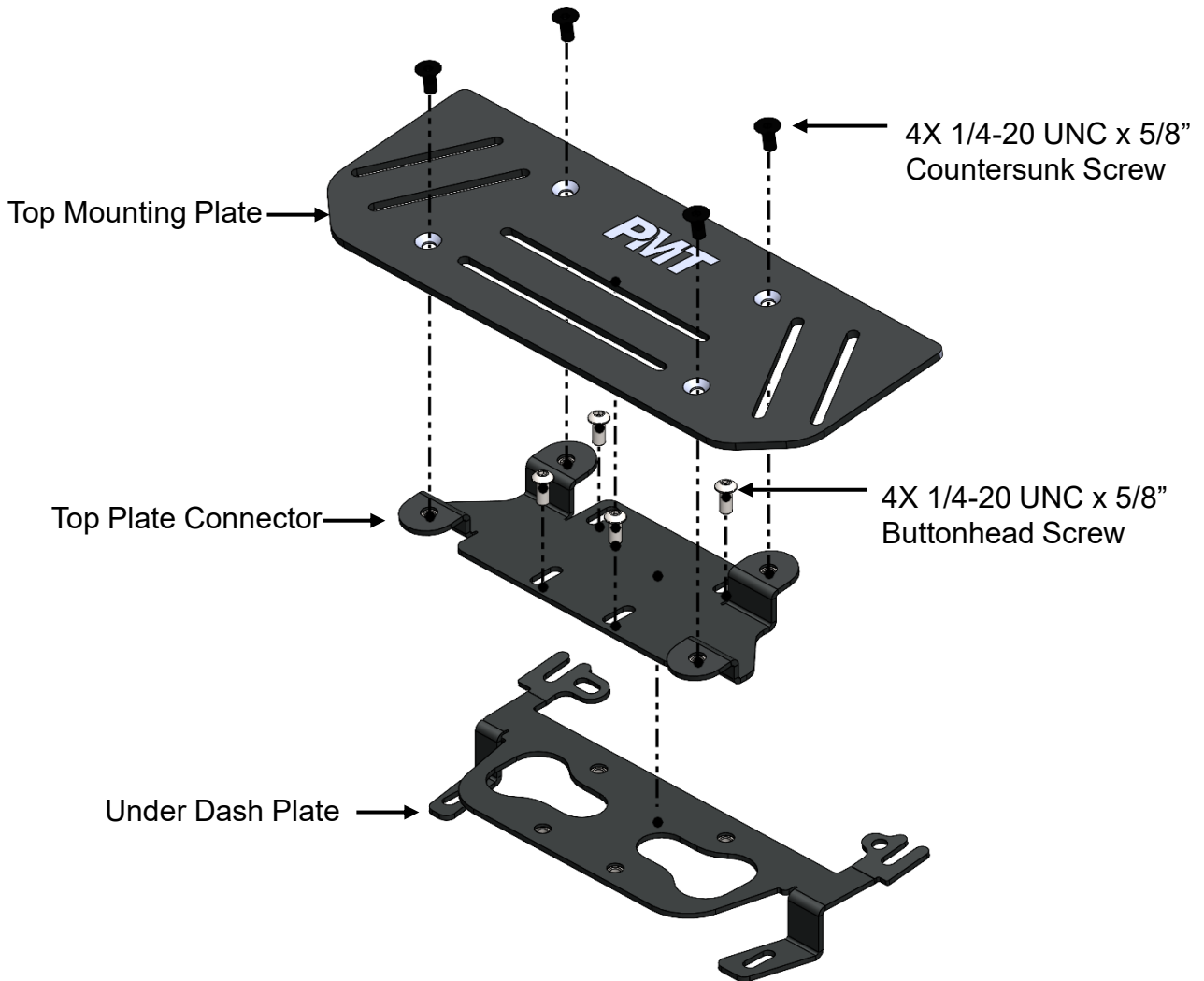

- **Top Mounting Plate:** This is the plate that all your device mounts will connect to.
- **Top Plate Connector:** This is the part that the top mounting plate directly connects to.
- **Under Dash Plate:** This is the part that goes underneath the OEM plastic dash panels.



AS4.C235.015



AS4.C235.017

INSTALLATION INSTRUCTIONS

(AS4.C235.014)

Tools required:

- 7mm Ratchet
- 5/32" Allen Wrench
- Ø 5/16" Drill
- Ø 1/8" Drill
- Masking Tape

Step 1

Remove rubber tray and gently pry the speaker cover up and off the dash

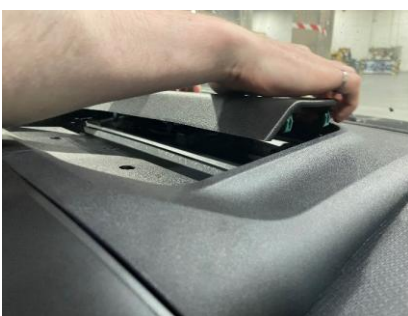

INSTALLATION INSTRUCTIONS

(AS4.C235.014)

Step 2

Remove the bolts holding the plastic trim panel on and set them aside for later



Step 3

Remove the bolts holding the speaker on, set them aside, then disconnect the speaker cable and set the speaker aside

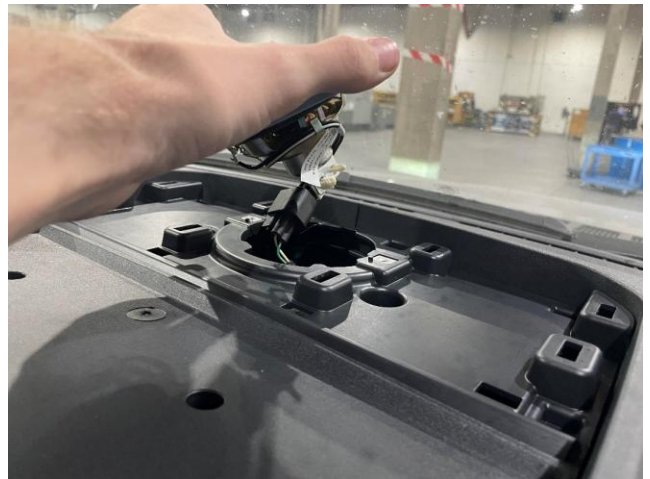

INSTALLATION INSTRUCTIONS

(AS4.C235.014)

Step 4

Remove the plastic tray starting by prying at the front then moving to the back until all clips are disconnected



INSTALLATION INSTRUCTIONS

(AS4.C235.014)

Step 5

Loosen the 2 upper bolts as shown below until there is about 1/4" to 3/8" of clearance between the washer and the OEM metal plate

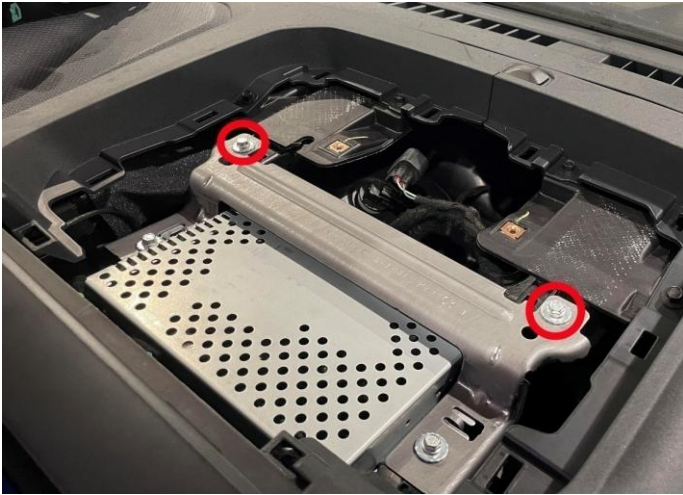

Step 6

Remove the 2 lower bolts and set them aside

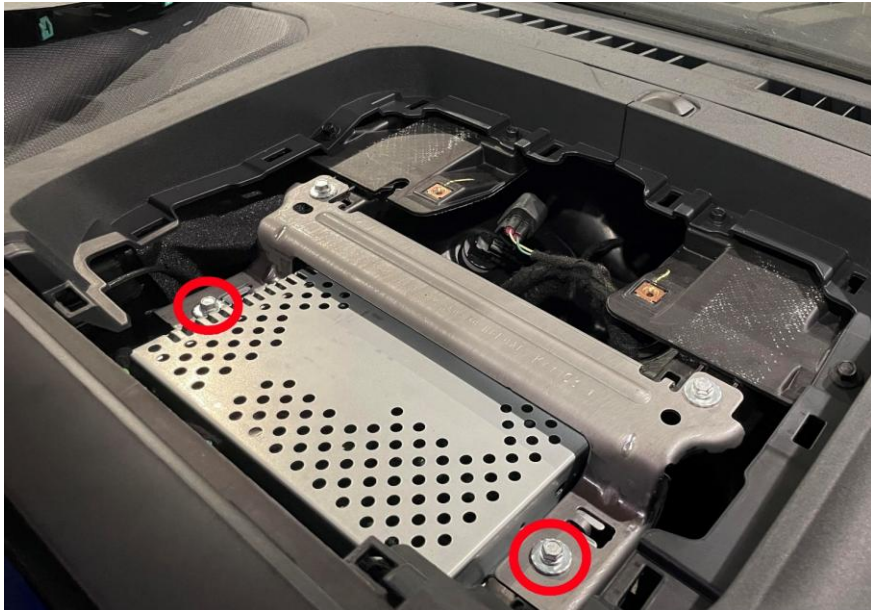

INSTALLATION INSTRUCTIONS

(AS4.C235.014)

Step 7

Install 4 of the buttonhead screws into the under plate as shown, these will be used to mark the locations to drill the holes in the plastic trim panel

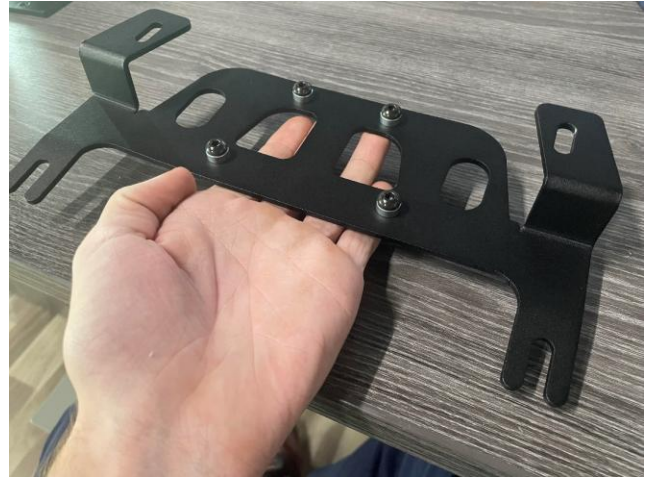
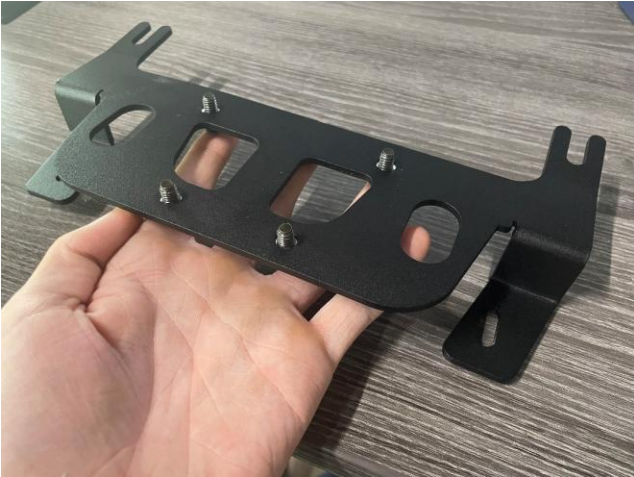

Step 8

Install the underplate with screws as shown, sliding it on to the loosened screws. Slide the screws all the way into the back of the slots on the underplate as far as possible.



Step 9

Tighten the screws down so the plate will not move when pushed

INSTALLATION INSTRUCTIONS

(AS4.C235.014)

Step 10

Place a piece or pieces of masking tape on the underside of the plastic tray panel as shown, the masking tape will be marked by the screws in the underplate showing where to drill the holes.

Note: you can place masking tape to get the marks from the front and rear screws on the underplate or just mark either the front or the rear screws and use the under plate as a template to mark the locations of the other two



Step 11

Position the plastic tray panel in the dash as it would be installed and push down approximately where the screws in the under panel will be. Remove the underplate and remove the buttonhead screws, reinstall the underplate putting in all four OEM bolts

INSTALLATION INSTRUCTIONS

(AS4.C235.014)

Step 12

Using the 1/8" drill bit to pilot drill the holes marked with the tape. If the holes land on a plastic ridge a utility blade can be used to remove the ridges

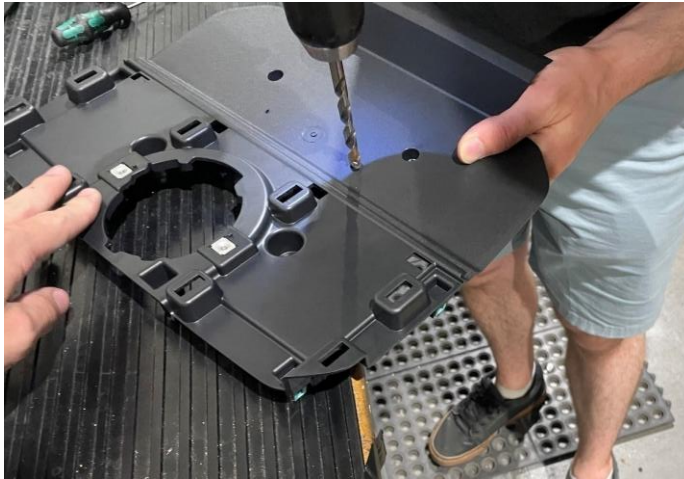

Step 13*

If you only marked one set of holes with tape drill out the holes you did mark with a 5/16" bit. Layout the underplate on the plastic trim panel and use two of the buttonhead screws to secure it in place, mark and drill the remaining two holes



INSTALLATION INSTRUCTIONS

(AS4.C235.014)

Step 14

Use a larger 5/16" drill bit to widen the holes. 5/16" is a recommendation, larger bits can be used for larger clearance if you feel your marked holes won't line up



Step 15

Reinstall the plastic tray and check that all the drilled holes lineup with the under plate before re-engaging the clips on the plastic tray. If the holes do not visually line up, then lift the tray piece and adjust the forward/back and left/right position of the underplate by loosening the OEM bolts and sliding it to the desired direction. You can also check the alignment by attempting to thread a button head screw into the underplate through the plastic tray

When all holes line up reinstall the plastic tray and OEM bolts that hold the plastic tray. Reconnect the speaker and reinstall the bolts that hold the speaker in. Reinstall the plastic speaker cover ensuring all clips re-engage

INSTALLATION INSTRUCTIONS

(AS4.C235.014)

Step 16

Connect the top plate connector to the underplate using 4 of the buttonhead screws, these screws connect the two parts through the holes drilled in the plastic plate. Locating the top plate connector in the middle of its slots is a good starting point



Step 17

Install all the mounts you want to have on your dash mount onto the top mounting plate in the position you want them (such as mobile device holders) these can be changed later with minimal disassembly. There are potential interferences with the top plate connector depending on the mount being installed onto the top plate. If there is interference, we recommend using buttonhead type screws with nuts and washers (pictured below)



INSTALLATION INSTRUCTIONS

(AS4.C235.014)

Step 18

Connect the top mounting plate to the top plate connector using 4 of the countersunk screws.



Step 19

Check the fit of the top mounting plate, if there is any interference you can change the position of the top plate by moving the top plate connector (middle component).

